

Ready, Set, Deploy:

Exchange Server 2013

Jeff Mealiffe
Principal Program Manager
Microsoft

Agenda

Upgrade Approach

Preparing for Exchange 2013

Upgrade and Coexistence

Moving Mailboxes and Public Folders

Lessons Learned

Architectural Changes in Exchange 2013

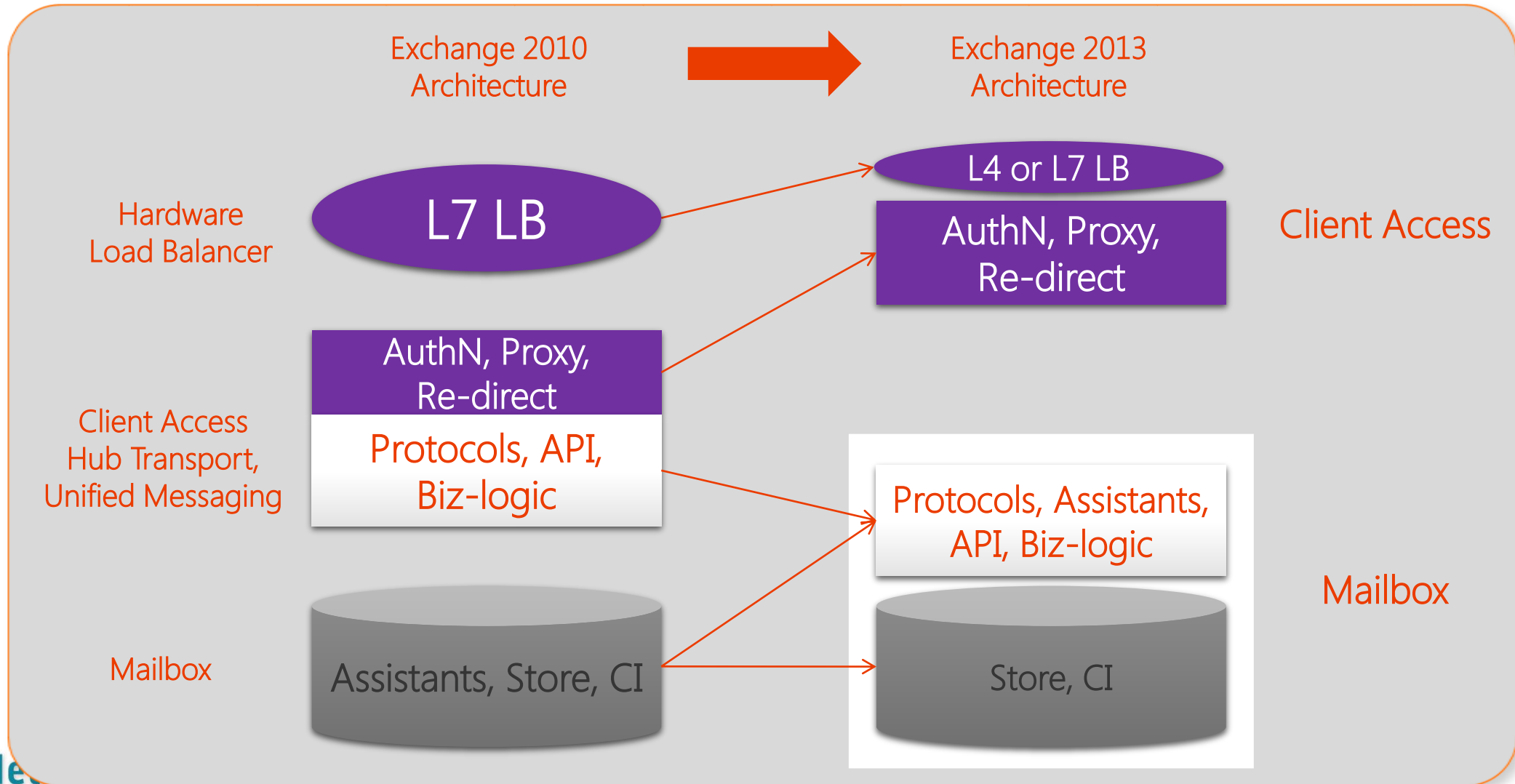

Upgrading from Exchange 2010



Clients

autodiscover.contoso.com
mail.contoso.com

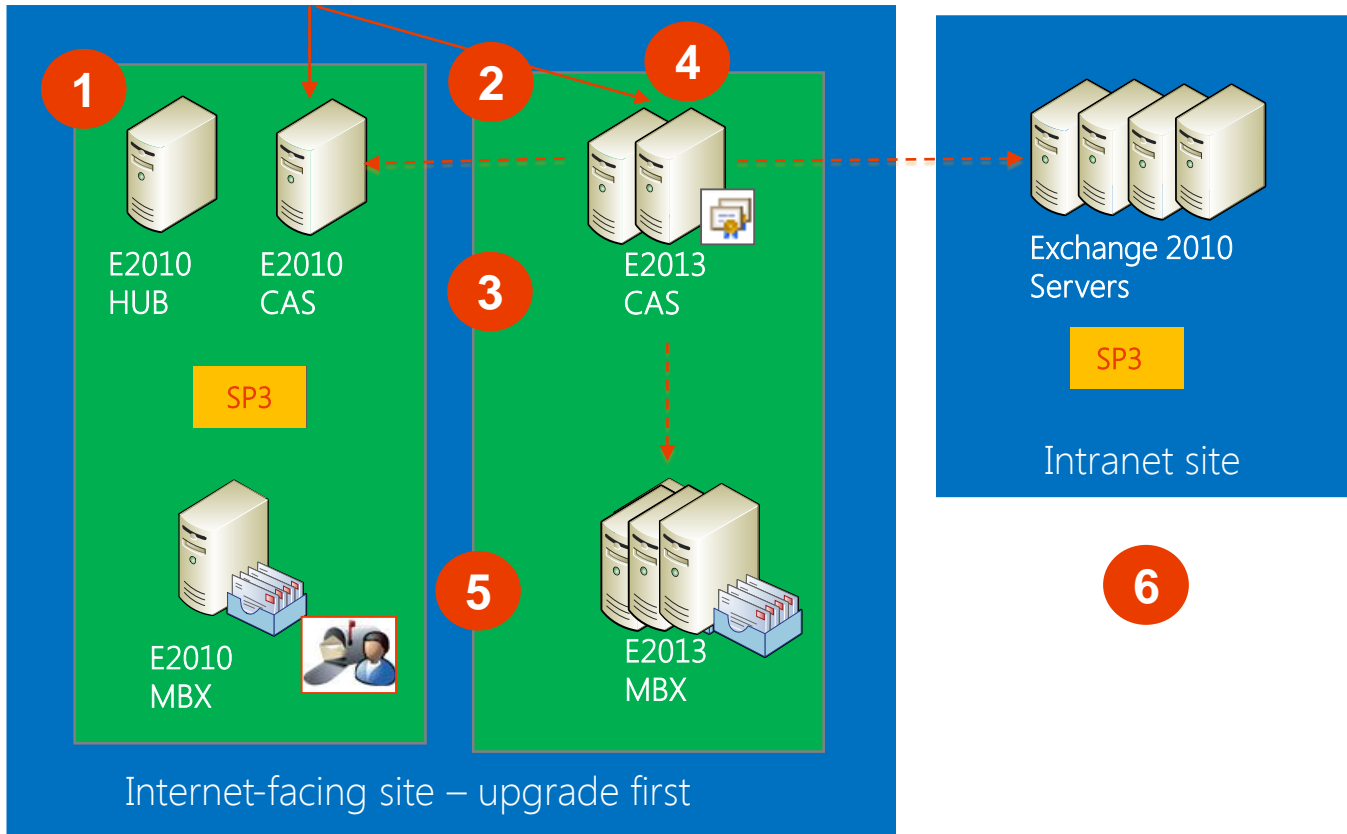

1. Prepare
 - Verify prerequisites
 - Install Exchange 2010 SP3 across the ORG
 - Prepare AD with Exchange 2013 schema
 - Validate existing client access
3. Obtain and deploy certificates
 - Obtain and deploy certs on Exchange 2013 CAS
4. Switch primary namespace to Exchange 2013 CAS
 - Exchange 2013 fields all traffic, including traffic from Exchange 2010 users
 - Validate using Remote Connectivity Analyzer
5. Move Mailboxes
 - Build database availability group
 - Move Exchange 2010 users to Exchange 2013
 - Migrate to Modern Public Folders
6. Repeat for additional sites

Upgrading from Exchange 2007



Clients

autodiscover.contoso.com

mail.contoso.com

legacy.contoso.com

3

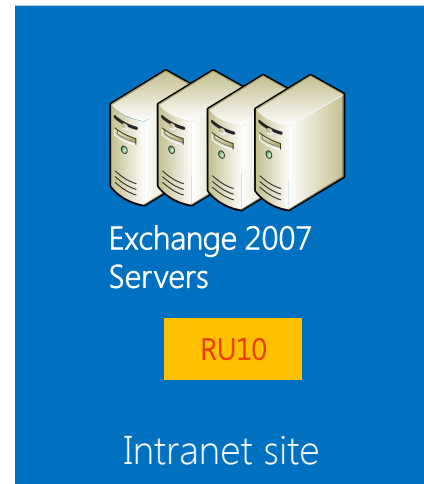
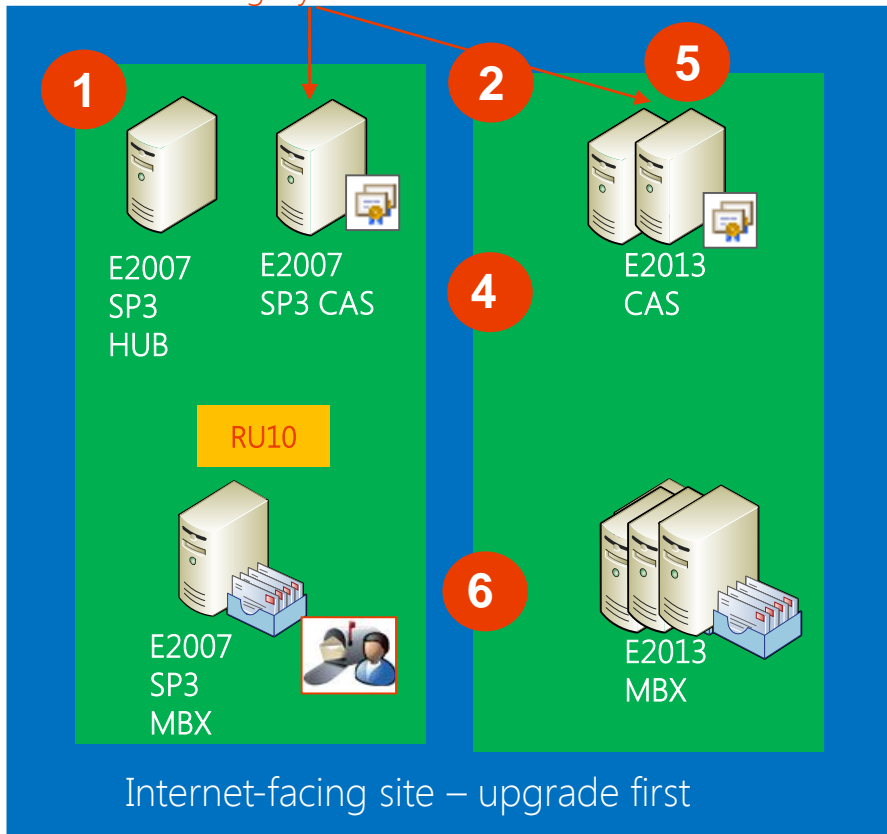

7

1. Prepare
 - Verify prerequisites
 - Install Exchange 2007 SP3 + RU10 across the ORG
 - Prepare AD with Exchange 2013 schema
 - Validate existing client access
2. Deploy Exchange 2013 servers
 - Install both Exchange 2013 MBX and CAS servers
3. Create legacy namespace
 - Create DNS record pointing to Exchange 2007 CAS
4. Obtain and Deploy Certificates
 - Obtain and deploy certificates on Exchange 2013 CAS
 - Deploy certificates on Exchange 2007 CAS
5. Switch primary namespace to Exchange 2013 CAS
 - Validate using Remote Connectivity Analyzer
6. Move mailboxes
 - Build out database availability group
 - Move Exchange 2007 users to Exchange 2013
 - Migrate to Modern Public Folders
7. Repeat for additional sites

Preparing for Exchange Server 2013

Exchange 2013 Prerequisites

Supported coexistence scenarios

Exchange Server 2010 SP3 or later

Exchange Server 2007 SP3 RU10 or later

Recommended Versions fix an issue with Outlook using the wrong Exchange 2013 Internal/External settings

Supported client access methods

Outlook Version	Supported Version	Recommended Version
Outlook 2013	RTM	Outlook 2013 SP1
Outlook 2010	SP1 + Nov 2012 Update (14.0.6126.5000 or later)	September 2014 update
Outlook 2007	SP3 + Nov 2012 Update (12.0.6665.5000 or later)	April 2014 update

RPC over HTTP only method of connectivity for Outlook 2013 pre-SP1 clients

Entourage 2008 for Mac, Web Services Edition

Outlook for Mac 2011

Prerequisites

Operating System (64-bit)

Windows Server 2008 R2 SP1 Standard or Enterprise

Windows Server 2012 Standard or Datacenter

Windows Server 2012 R2 Standard or Datacenter (Exchange Server 2013 SP1 and later only)

IIS and other Windows components

.NET Framework 4.5

4.5.1 required if deploying MAPI over HTTP

Windows Management Framework 3.0

Unified Communications Managed API (UCMA) 4.0

Preparing for Exchange Server 2013

Install required updates on legacy Exchange servers

Prepare Active Directory for Exchange 2013

Extend the schema: Setup /PrepareSchema or /ps

Prepare the Exchange organization: Setup /PrepareAD or /p

Prepare remaining domains that have or will have mail-enabled objects:

- Local domain: Setup /PrepareDomain or /p

- Remote domains: Setup /PrepareDomain:FQDN.of.domain or /p:FQDN.of.domain

- All domains at once: Setup /PrepareAllDomains or /pad

Validate existing client access using Remote Connectivity Analyzer and test connectivity cmdlets

<http://www.exrca.com>

Deploying Exchange 2013

Exchange 2013 Setup

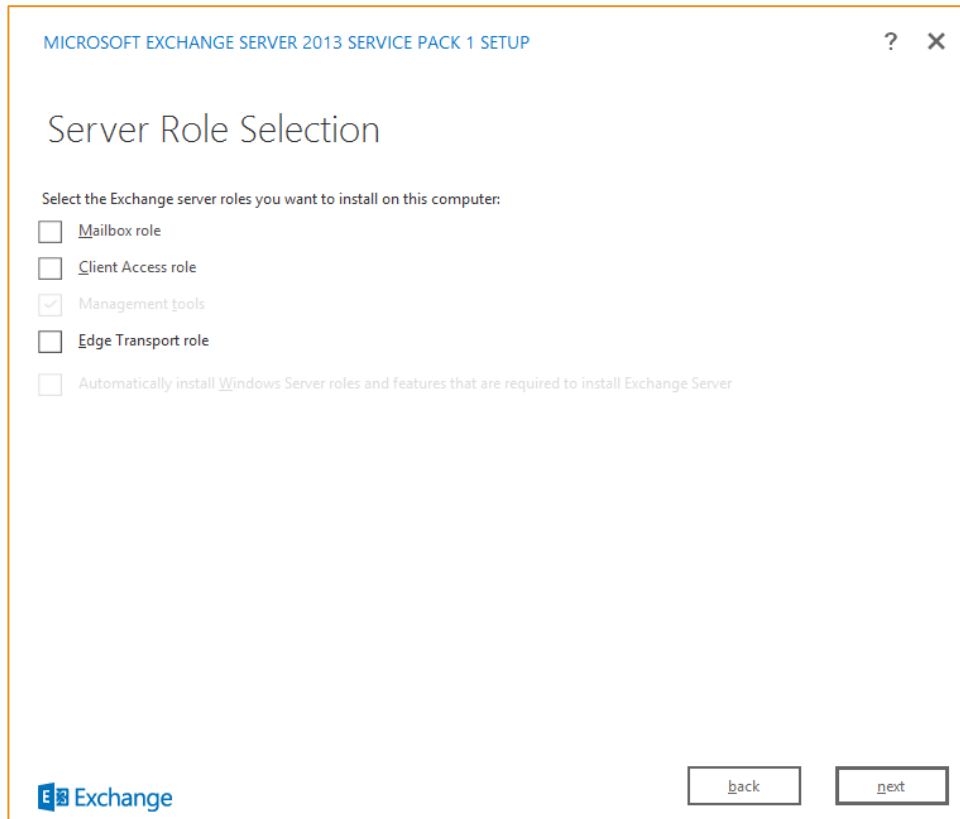

Install both MBX and CAS roles

Cannot uninstall individual roles

Use the latest CU/SP package

No more update rollups

Exchange 2013 Setup

GUI and command line available

Command line parameters

New parameter for license terms acceptance

```
Setup.exe /mode:install /roles:c,m,mt /IAcceptExchangeServerLicenseTerms
```

Create Legacy Namespace

Create Legacy Namespace

Required for Exchange 2007 coexistence only

Used to access Exchange 2007 during coexistence

Create DNS record in internal and external DNS for legacy namespace

Validate legacy namespace creation via Remote Connectivity Analyzer

<http://www.exrca.com>

Certificates

Certificates – Exchange Admin Center

End-to-end certificate wizard

Export and import with private key to all other CAS



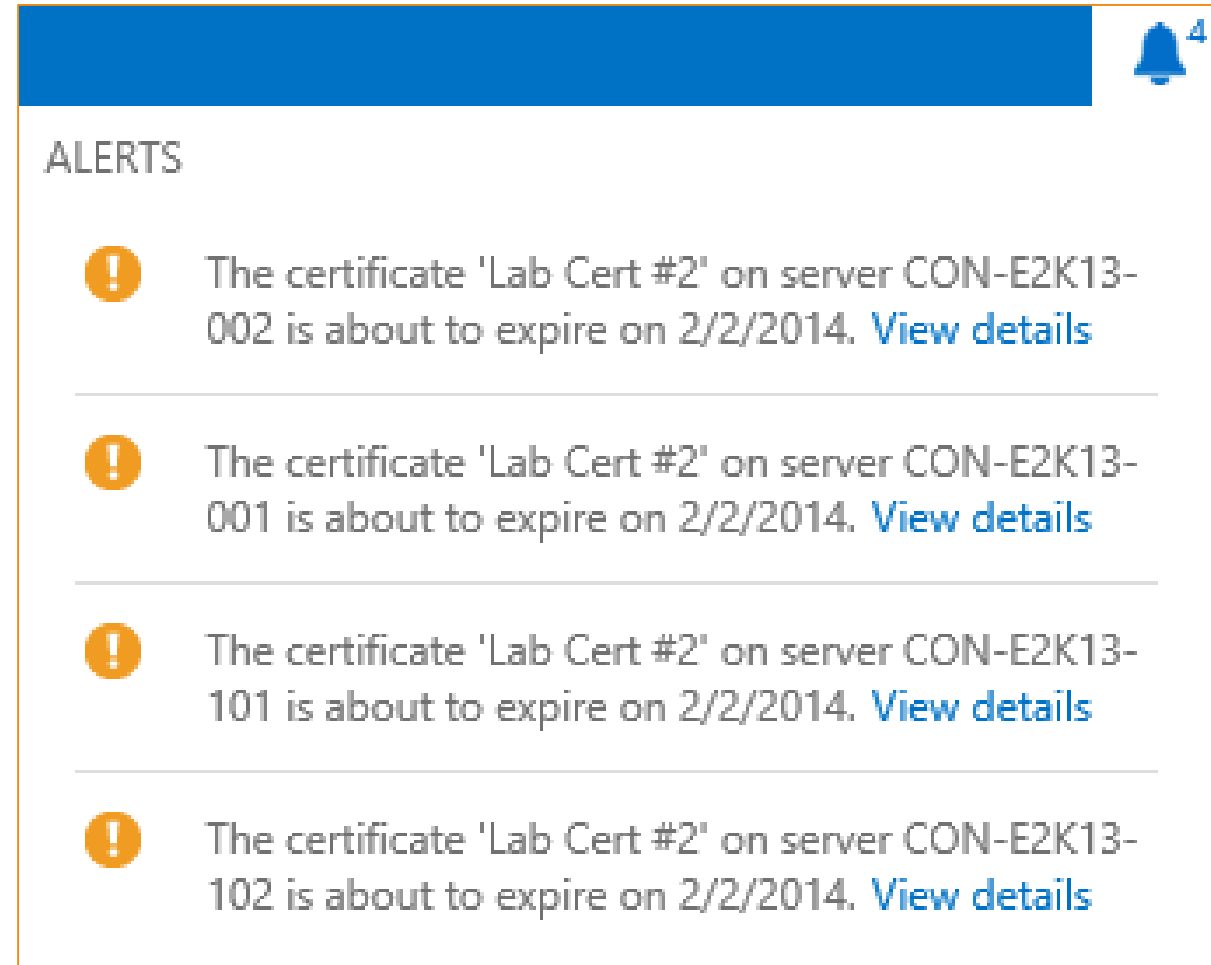

Assign services to certificates

Alerts when a certificate is about to expire

First alert 30 days prior to expiration
Subsequent alerts every 24 hours



The screenshot shows the Alerts section of the Exchange Admin Center. It features a blue header bar with a notification bell icon in the top right corner. Below the header, the word "ALERTS" is displayed in a bold, sans-serif font. There are four alert items, each consisting of a yellow circular icon with a white exclamation mark, followed by a text message and a blue "View details" link. The alerts are separated by horizontal lines.

-  The certificate 'Lab Cert #2' on server CON-E2K13-002 is about to expire on 2/2/2014. [View details](#)
-  The certificate 'Lab Cert #2' on server CON-E2K13-001 is about to expire on 2/2/2014. [View details](#)
-  The certificate 'Lab Cert #2' on server CON-E2K13-101 is about to expire on 2/2/2014. [View details](#)
-  The certificate 'Lab Cert #2' on server CON-E2K13-102 is about to expire on 2/2/2014. [View details](#)

Certificates - Best Practices

Minimize the number of certificates

A unified namespace means the same cert is used on all CAS in a site-resilient datacenter pair

Use Subject Alternative Name (SAN) certificates

Minimize number of hostnames

Use split or pinpoint DNS for Exchange hostnames if using the same auth type inside and out

Don't list machine names in certificate hostname list

Use load balanced CAS arrays for intranet and Internet access

Certificates - Best Practices

Did your Outlook Providers look like this previously when using a wildcard cert?

```
Name CertPrincipalName
-----
EXCH
EXPR msstd:*.contoso.com
WEB
```

Outlook Anywhere settings now dynamically generated off both the EXCH and EXPR Outlook Providers for separate internal and external settings for clients

```
Name CertPrincipalName
-----
EXCH msstd:*.contoso.com
EXPR msstd:*.contoso.com
WEB
```

As a result of this update both Outlook providers must be wildcard-ready in order to use a wildcard certificate

Moving client namespaces to Exchange 2013

Switching to CAS 2013

Drop TTL of DNS records you will be changing in advance

Re-test with Remote Connectivity Analyzer one last time

If necessary,

- Reconfigure Virtual Directory Settings of legacy systems

- Reconfigure Outlook Anywhere on legacy systems

- Move systems into the production AD sites

- Update Publishing methods (Load Balancer, Reverse Proxy, etc...)

Update DNS records

Test with Remote Connectivity Analyzer once DNS updates propagate

Switching to CAS 2013 (Outlook Anywhere)

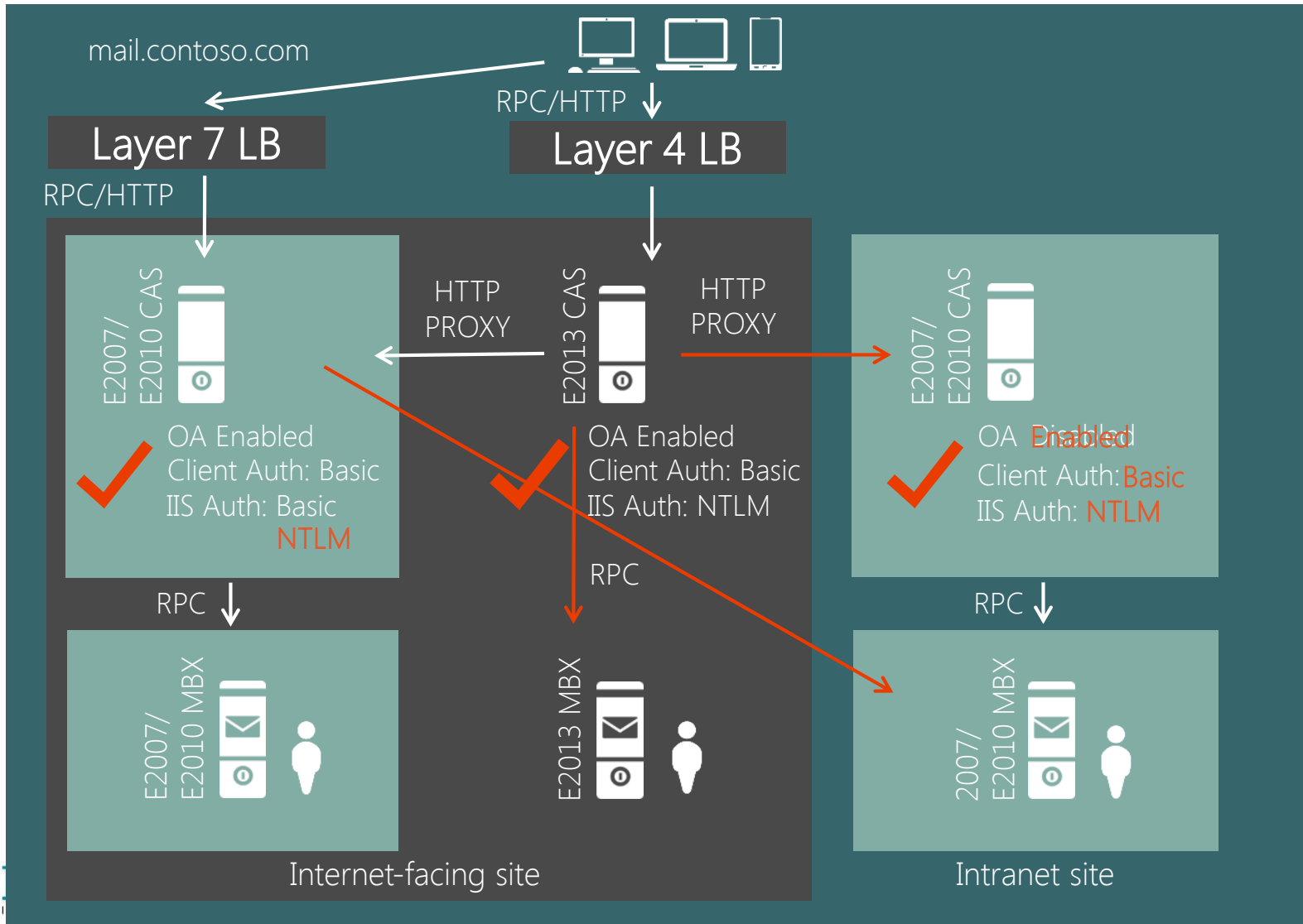

1. Enable Outlook Anywhere on all legacy CAS
Use 'mail.contoso.com' namespace for all CAS so traffic flows through 2013 in all cases
2. IIS Authentication Methods
IIS Auth must have NTLM enabled on all legacy CAS
3. Preparing for DNS Cutover
Use a low TTL on the existing records a few days in advance of the cutover

Basic auth for clients is shown in this example. If you prefer NTLM, then use NTLM.

Client Protocol Connectivity Flow

Legacy Coexistence

Protocol	Exchange 2007 user accessing Exchange 2010 namespace	Exchange 2007 user accessing Exchange 2013 namespace	Exchange 2010 user accessing Exchange 2013 namespace
Requires	Legacy namespace	Legacy namespace	No additional namespaces
OWA	<ul style="list-style-type: none"> • Same AD site: silent or SSO FBA redirect • Externally facing AD site: manual or silent/SSO Cross-site redirect • Internally facing AD site: proxy 	Silent redirect to CAS 2007 ExternalURL in same or different AD site	<ul style="list-style-type: none"> • Same AD Site: Proxy to CAS 2010 • Different AD Site: Cross-site silent redirect to ExternalURL
EAS	<ul style="list-style-type: none"> • EAS v12.1+ : Autodiscover & redirect • Older EAS devices: proxy 	Proxy to MBX 2013	Proxy to CAS 2010 - all noted protocols
Outlook Anywhere	Direct CAS 2010 support	Proxy to CAS 2007	
Autodiscover	Exchange 2010 answers Autodiscover query for 2007 User	Exchange 2013 answers Autodiscover query for 2007 User	
EWS	Uses Autodiscover to find CAS 2007 EWS External URL	Uses Autodiscover to find CAS 2007 EWS External URL	
POP/IMAP	Proxy	Proxy to CAS 2007	
OAB	Direct CAS 2010 support	Proxy to CAS 2007	
RPS	n/a	n/a	
ECP	n/a	n/a	<ul style="list-style-type: none"> • Same AD Site: Proxy to CAS 2010 • Different AD Site: Cross-site silent redirect to ExternalURL

Move mailboxes to Exchange 2013

Exchange Server 2013 Mailbox Moves

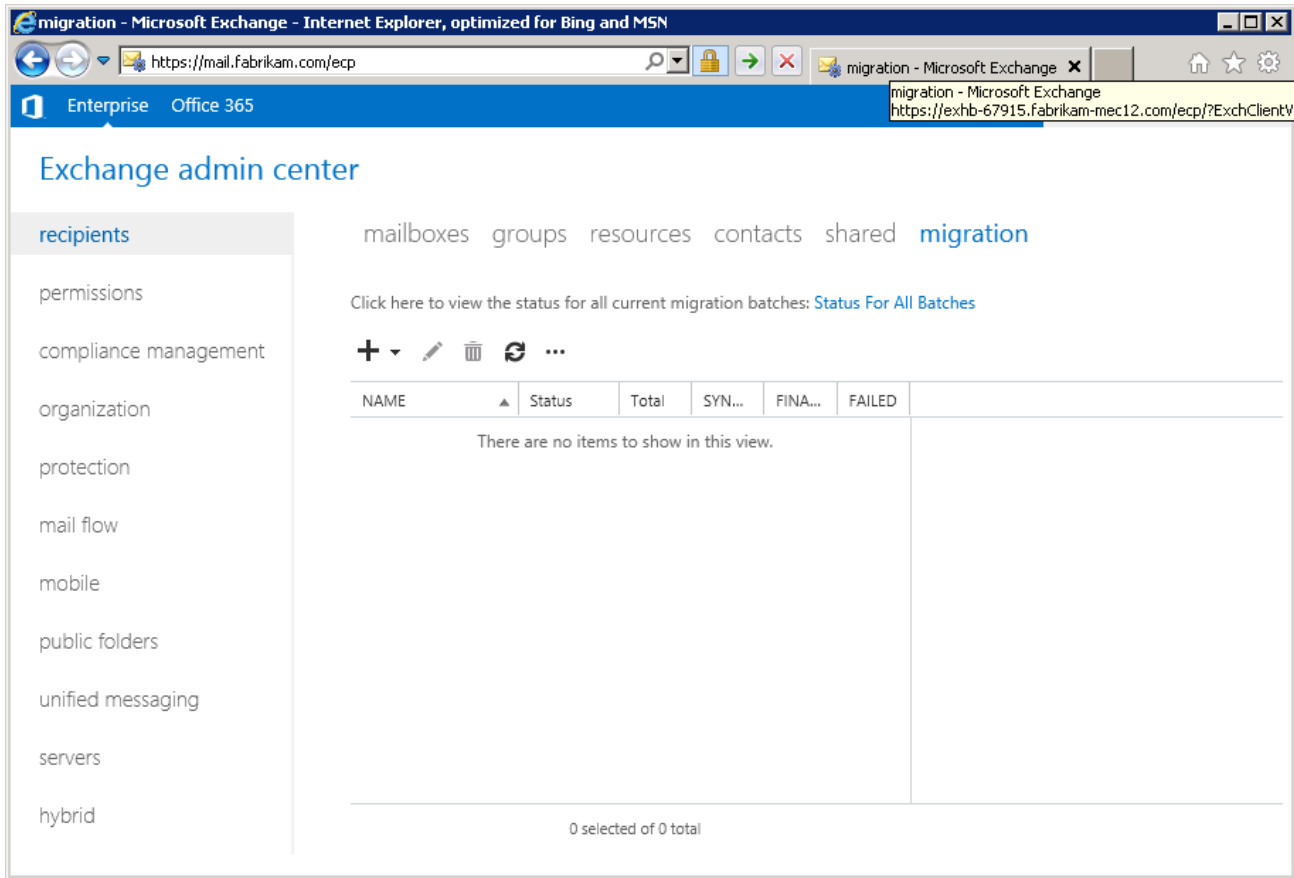

New migration service

Batch management

Reporting

Retry semantics

Uses Mailbox Replication Service (MRS) internally

Move from EAC or use cmdlets

New-MigrationBatch

Get-MigrationUserStatistics

Managing Coexistence

Managing Coexistence

Use Exchange 2013 Admin Center (EAC) to:

- Manage Exchange 2013 mailboxes

- Manage Exchange 2013 certificates

- Manage Exchange 2013 servers

- Manage some Exchange 2007/2010 server attributes

- View and update Exchange 2010/2007 mailboxes and properties (with a few limitations)

Use Exchange 2010/2007 Management Console (EMC) to create legacy mailboxes

Public Folders

Exchange 2013 Public Folders

Database-centered architecture replaced by mailbox

Existing Public Folders can be migrated to Exchange 2013

Public Folder Replication is removed

End user experience doesn't change

Migrate Public Folder users before Public Folders

Exchange 2013 users can access legacy Public Folders

Exchange 2010/2007 users cannot access modern Public Folders

Migration from legacy to modern Public Folders is a cut-over process

Public Folder Migration Process

Analyze existing Public Folders

Tool available to analyze existing Public Folder hierarchy to determine how many Exchange 2013 Public Folder mailboxes are recommended

Copy Public Folder data

Users continue to access legacy Public Folders while data is copied
Data migration happens in the background

Switch clients to Exchange 2013 Public Folders

There will be a short downtime while the migration is finalized
Once migration completes, everyone switches at the same time
Can switch back, but any post migration Public Folder changes are lost

Public Folder Migration

from Exchange 2010

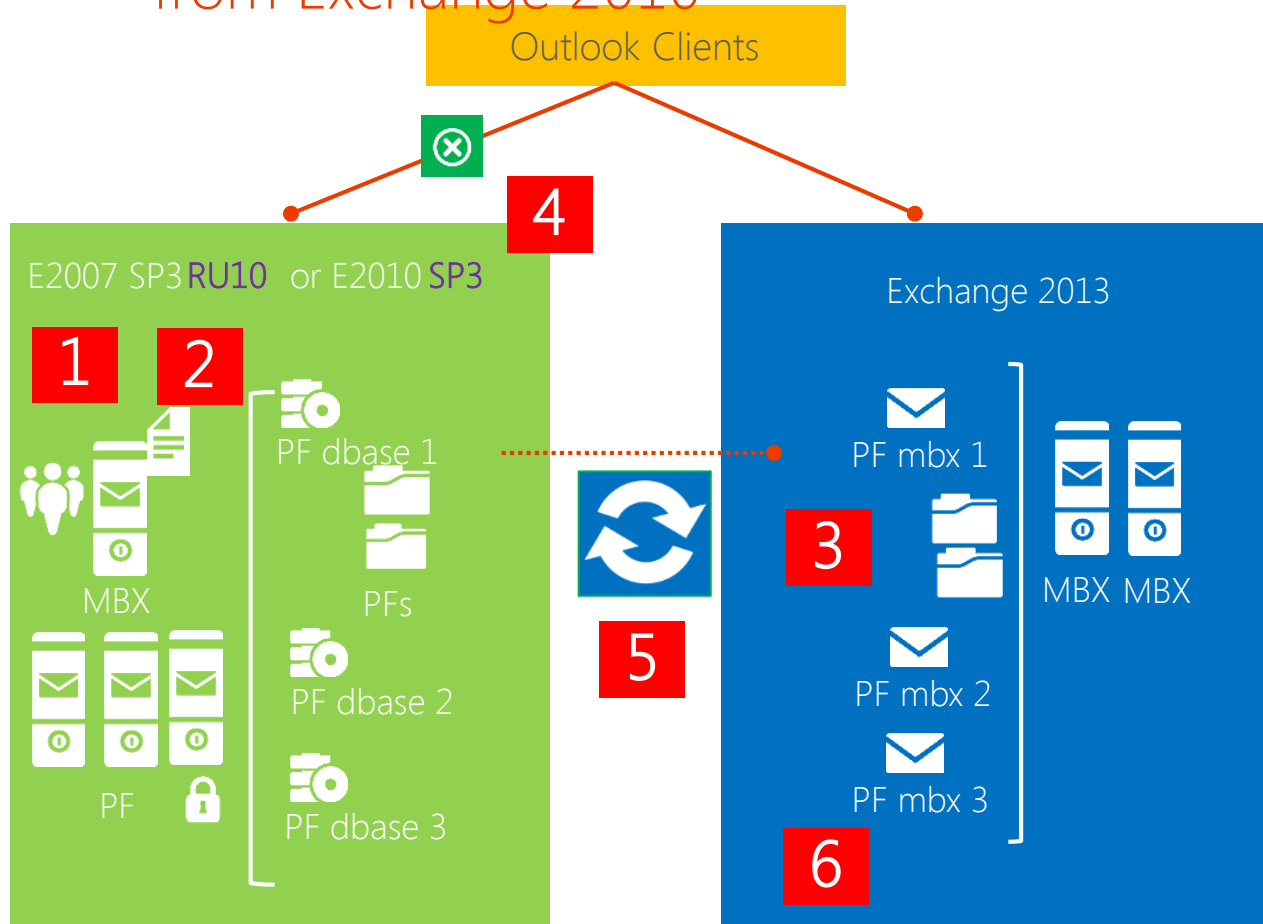

1. Prepare

- Install Exchange SP and/or updates across the ORG
- Migrate all users that require access to Exchange 2013

2. Analyze

- Take snapshot of existing PF folder structure, statistics and permissions
- Map PF folders to PF mailboxes

3. Create new Public Folder mailboxes

- Set to *HoldForMigration* Mode, mailboxes invisible to clients

4. Begin Migration Request

- Clients continue to access and create new data during copy
- After copy is complete migration request status is *AutoSuspended*

5. Finalize Migration Request

- Update snapshot of existing PF folder structure, statistics and permissions
- Lock source, clients logged off, final sync occurs

6. Validate

- Check and verify destination folders

EWS Clients and Legacy Public Folders

EWS clients with mailboxes on 2013 will not be able to access legacy PFs

Entourage 2008 EWS Edition

Outlook for Mac 2011

Custom EWS scripts accessing PF data



Lessons Learned

OAB Downloads

Do you have or plan to have multiple OABGen capable mailboxes?

Know that client OAB downloads from different OABGen mailboxes triggers a full download even if it is the same OAB being downloaded

How to find your OABGen mailbox(es):

```
[PS] C:\>Get-Mailbox -Arbitration | Where {$_.PersistedCapabilities -like "*OAB*"} | FL Name,Database,Persis*
```

```
Name           : SystemMailbox{bb558c35-97f1-4cb9-8ff7-d53741dc928c}
Database       : 2013DB-001
PersistedCapabilities : {OrganizationCapabilityUMGrammarReady, OrganizationCapabilityPstProvider,
                        : OrganizationCapabilityMessageTracking, OrganizationCapabilityMailRouting,
                        : OrganizationCapabilityClientExtensions, OrganizationCapabilityGMGen,
                        : OrganizationCapabilityOABGen, OrganizationCapabilityUMGrammar}
```

```
Name           : OABGen02
Database       : 2013DB-002
PersistedCapabilities : {OrganizationCapabilityOABGen}
```

OAB Downloads

How does this happen to clients? You may have OABGen mailboxes in different or same AD sites

```
[PS] C:\>Get-MailboxDatabase
```

Name	Servers
2013DB-001	{CON-E2K13-001}
2013DB-002	{CON-E2K13-001}
2013DB-003	{CON-E2K13-101}
2013DB-004	{CON-E2K13-102}
2013DB-005	{CON-E2K13-101}
2013DB-006	{CON-E2K13-002}

```
[PS] C:\>Get-Mailbox -Arbitration | Where {$_.PersistedCapabilities -AutoSize}
```

Name	Database
OABGen02	2013DB-003
SystemMailbox{bb558c35-97f1-4cb9-8ff7-d53741dc928c}	2013DB-001

```
[PS] C:\>
```

```
[PS] C:\>Get-ExchangeServer | Where {$_.AdminDisplayVersion -like "*15*"} | Name,Site
```

Name	Site
CON-E2K13-001	corp.contoso.com/Configuration/Sites/Boston
CON-E2K13-002	corp.contoso.com/Configuration/Sites/Boston
CON-E2K13-101	corp.contoso.com/Configuration/Sites/Seattle
CON-E2K13-102	corp.contoso.com/Configuration/Sites/Seattle
CON-E2K13-EDG01	corp.contoso.com/Configuration/Sites/Seattle

OAB Downloads

Could we place different OABGen mailboxes in DBs only replicated locally?

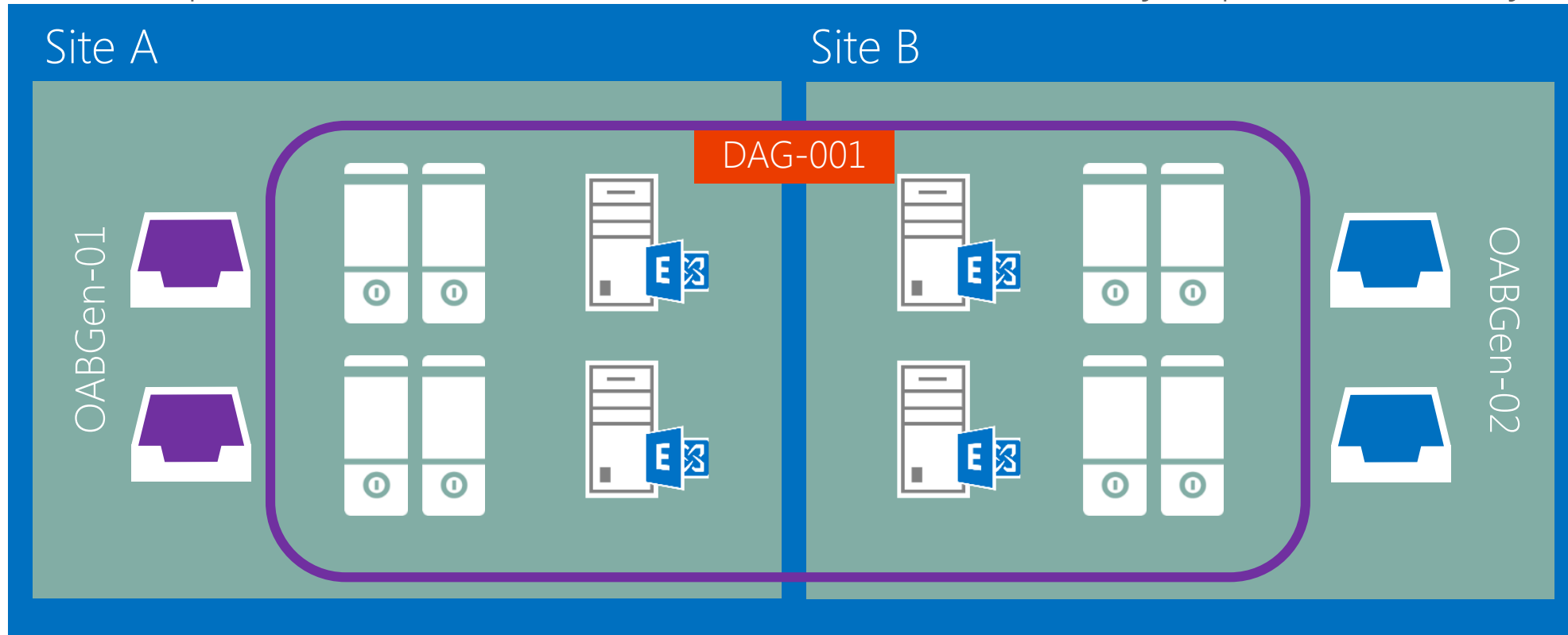

No, in this example the DAG spans two sites and user mailboxes will move between sites

OAB Downloads

Recommendation: Keep one OABGen mailbox per organization

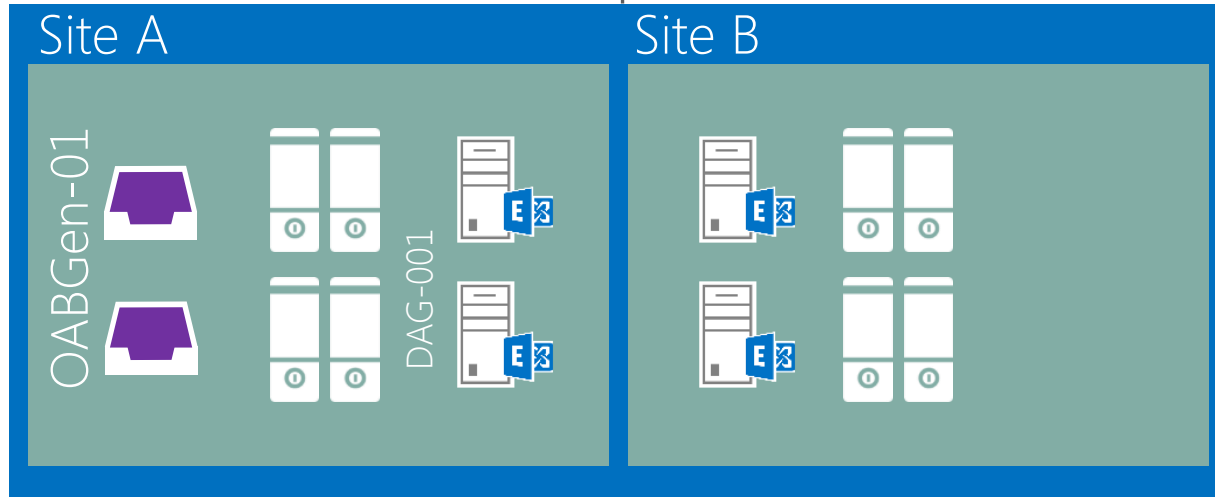

or

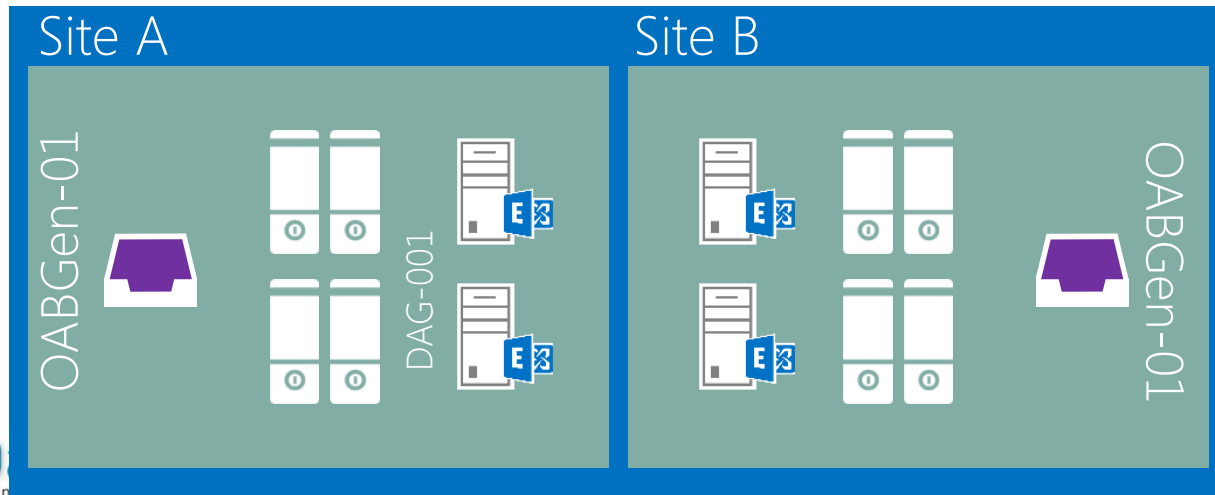

Recommended due to site resiliency gains

Quota Calculations

Mailbox and Public Folder data moved to Exchange 2013 will appear to grow due to more accurate calculations within the DB

Expectation is 30%-40% increase in quota hit, but will vary based on the content types

Increase quota of any user using ~75% or more of their quota prior to moving them to 2013

The database size on disk does NOT increase

Upgrade and Coexistence Summary

Updates are required for Exchange Server 2013 SP1 coexistence

Exchange Server 2010 SP3 or 2007 SP3 RU10 are required, including Edge Transport servers

Exchange 2007 requires a legacy namespace for coexisting with Exchange 2013

Edge Transport is in SP1 and later

Same functionality as Exchange 2010; managed via PowerShell or Edge Subscription

Exchange Server 2013 Deployment Assistant

<http://technet.microsoft.com/en-us/exchange/jj657516.aspx>

